

Model 5600 & 5600 Econominder®

Service Manual

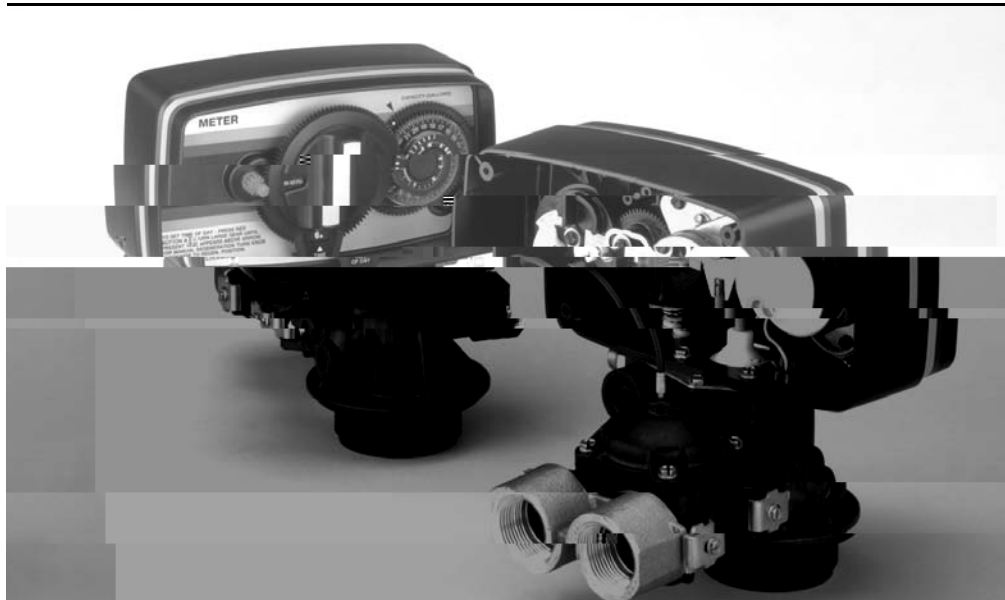

Table of Contents

<i>Job Specification Sheet</i>	3
<i>General Residential Installation Check List</i>	4
<i>Valve Installation and Start-up Procedures</i>	5
<i>Model 5600 Installation and Start-up Procedures</i>	6
<i>Model 5600 Backwash Filter Installation and Start-up Procedures</i>	7
<i>Model 5600 Econominder Installation and Start-up Procedures</i>	9
<i>Water Conditioner Flow Diagrams</i>	10
<i>Service Position</i>	10
<i>Preliminary Rinse Position</i>	10
<i>Backwash Position</i>	11
<i>Brine Position</i>	11
<i>Slow Rinse Position</i>	12
<i>Rapid Rinse Position</i>	12
<i>Settling Rinse Position</i>	13
<i>Brine Tank Fill Position</i>	13
<i>Model 5600 Control Valve Drive Assembly</i>	14
<i>Model 5600 and 5600 Econominder Control Valve Drive Assembly</i>	16
<i>Model 5600 Econominder Control Valve Drive Assembly</i>	18
<i>Bypass Valve Assembly, Plastic</i>	20
<i>Bypass Valve Assembly, Brass</i>	21
<i>Model 5600 Econominder Meter Assembly</i>	22
<i>Service Instructions</i>	23
<i>Replace Time Brine Valve, Injectors and Screen</i>	23
<i>Replace Timer</i>	24
<i>Replace Piston Assembly</i>	25
<i>Replace Seals and Spacers</i>	26
<i>Replace Meter</i>	27
<i>Replace Meter Cover and/or Impeller</i>	28
<i>Model 5600 and 5600 Econominder Troubleshooting</i>	29
<i>General Service Hints for Meter Control</i>	30
<i>Model 5600SF Troubleshooting</i>	31
<i>Service Assemblies</i>	32

Job Specification Sheet

Job Number _____

Model Number _____

Water Test _____

Capacity of Unit _____ Max. _____ Per Regeneration

Mineral Tank Size: Diameter _____ Height _____

Brine Tank Size and Salt Setting Per Regeneration: _____

Control Valve Specifications

Type of Timer: ___ Std. ___ "L" ___ 7-day ___ 12-day ___ Meter, Std. ___ Meter, Ext.

Day/Time of Regeneration _____

Drain Line F o Con.8(on3-24(t)15JT*0()8.24.1(_____)24(____ M)-15.3(a____)-24(____)-24(____ M)-15.3(gpm005

General Residential Installation Check List

Water Pressure

A minimum of 25 psi (1.7 bar) of water pressure is required for regeneration valve to operate effectively.

Electrical Facilities

An uninterrupted alternating current (A/C) supply is required. Please make sure voltage supply is compatible with unit before installation.

Existing Plumbing

Condition of existing plumbing should be free from lime and iron buildup. Replace piping that has heavy lime and/or iron build-up. If piping is clogged with iron, install a separate iron filter unit ahead of the water softener.

Location of Softener and Drain

Locate the softener close to a clean working drain and connect according to local plumbing codes.

Bypass Valves

Always provide for the installation of a bypass valve if unit is not equipped with one.

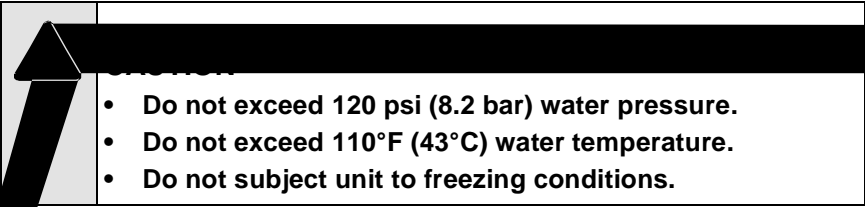
- 
- **Do not exceed 120 psi (8.2 bar) water pressure.**
 - **Do not exceed 110°F (43°C) water temperature.**
 - **Do not subject unit to freezing conditions.**

Model 5600 Installation and Start-up Procedures

NOTE: Install the water softener with the inlet, outlet and drain connections made according to manufacturer's recommendations and to meet applicable plumbing codes.

1. Manually index the softener control into the **In Service** position and let water flow into the resin tank. When the water flow stops, open a softened water tap until all air is released from the lines. Then close tap.

NOTE: Manually dial the various regeneration positions by turning the knob on the front of the control until the indicator shows that the softener is in the desired position.

2. Manually index the control to the **Backwash** position and allow water to flow at the drain for 3 or 4 minutes.

Model 5600 Backwash Filter Installation and Start-up Procedures

NOTE: Install the water softener with the inlet, outlet and drain connections made according to manufacturer's recommendations and to meet applicable plumbing codes.

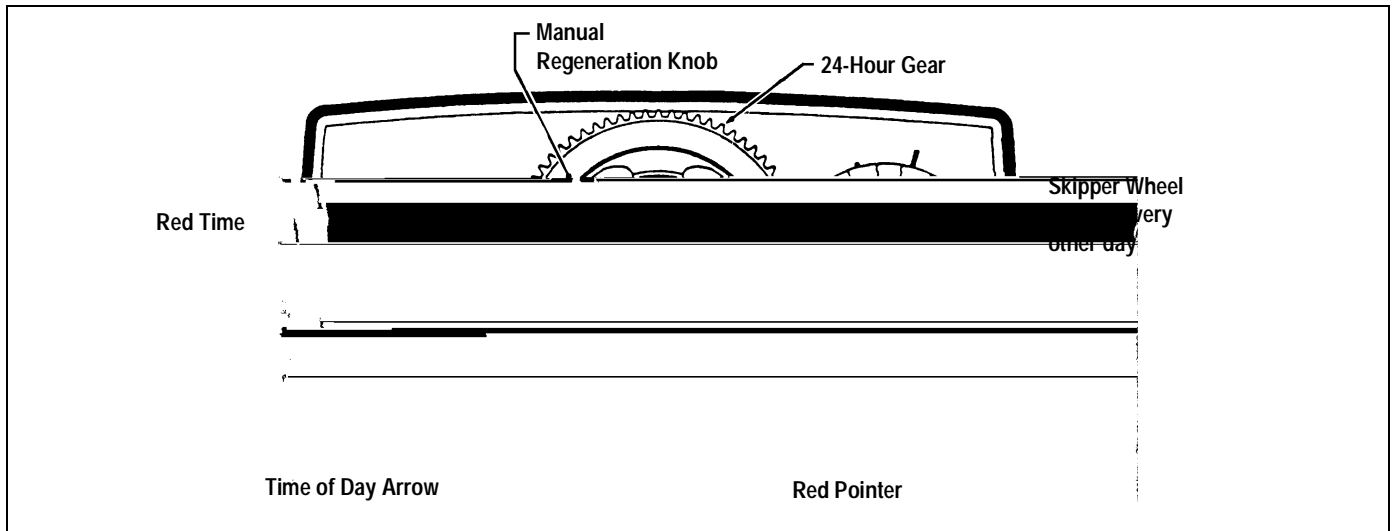

Figure 2: Model 5600 Backwash Filter Control

Before Plugging in the Unit

1. Open a treated water tap down stream of the filter.
2. Manually index the filter to the **In Service** position and allow the mineral tank to fill by slowly opening the main water supply valve. Any bypass should be in the **In Service** position.
NOTE: The water flowing from the downstream tap is cloudy and/or contains media fines as well as air. Allow the water to run until it appears clean and free of air.
3. When a steady clean flow appears at the tap, close the tap and the main water supply valve and allow the filter media bed to settle for 15–20 minutes.
4. Manually index the filter to the **Backwash** position.
5. To prevent a sudden surge of water and air, partially open the main water supply valve so that the flow at the drain of the filter is approximately 1 gpm (3.7 Lpm). The water at the drain is cloudy again and/or contains media fines as well as air. Allow water to flow at the drain until it appears clean and free of air.
6. Continue to open the water supply valve until it is completely open. Allow water to flow at the drain until all media fines are washed out of the filter.
7. Manually index the filter to the **In Service** position, and again open the downstream tap. Check to be sure that the water flows clear. If necessary, allow water to flow until all media fines are gone. If the tap is equipped with an aerator check that is not plugged with media fines and pipe scale.
8. Plug in the electrical cord and look in the sight hole on the back of the timer motor to ensure that it is running. Set the days backwashing is to occur by sliding tabs on the skipper wheel outward to expose trip fingers. Each tab is one day. Finger at red pointer is tonight. Moving clockwise from red pointer, extend or retract fingers to obtain the desired backwash schedule.
9. Set time of day by pushing red button and spin the 24-hour gear until the present time of day is visible above the time of day arrow.

Model 5600 Backwash Filter Installation & Start-up Procedures (Cont'd.)

Cycle Times and Flow Diagrams

1. **In Service** position. *See Figure 4, page 10.*
2. **Preliminary Rinse** position.
 - Same as *Figure 4, page 10* with standard piston (white end plug) or filter piston (black end plug).
 - Eliminated with low water piston (gray end plug).
3. **Backwash** position.
 - Same as *Figure 6, page 11* with standard piston.
 - 15 minutes with filter piston.
 - 7 minutes with low water piston.
4. **Brine Rinse** position.
 - Eliminated, resulting in a 50 minute pause, no water flows during this time.
5. **Slow Rinse** position.
 - Eliminated, resulting in a 50 minute pause, no water flows during this time.
6. **Second Backwash** position.
 - Same as *Figure 9, page 12* with standard piston.
 - 15 minutes with filter piston.
 - 7 minutes with low water piston.
7. **Settling Rinse** position.
 - Same as *Figure 10, page 13* with standard or filter piston.
 - Eliminate with low water piston.
8. **Brine Tank Refill** position.

Model 5600 Econominder Installation & Start-up Procedures

NOTE: Install the water softener with the inlet, outlet and drain connections made according to manufacturer's recommendations and to meet applicable plumbing codes.

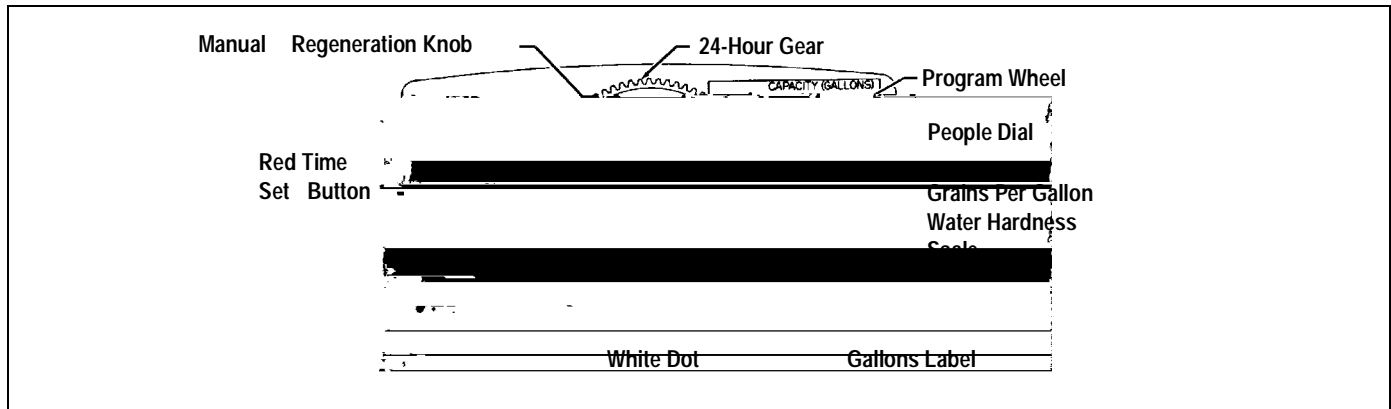

Figure 3: Model 5600 Econominder

1. Manually index the softener control to the **In Service** position and let water flow into the resin tank. When the water flow stops, open a softened water tap until all air is released from the lines. Then close tap.
NOTE: The various regeneration positions may be dialed manually by turning the knob on the front of the control until the indicator shows that the softener is in the desired position.
2. Set water usage program wheel using any one of the following procedures:
 - Typical Residential Application
To program, just set the time, set the hardness and it automatically monitors system needs and regenerates only when necessary. To set time of day press red time set button and turn 24-hour gear until present time of day is at "time of day." Set program wheel by lifting the "people" dial and rotating it so that the number of people in the household is aligned with the household grains per gallon water hardness. Release the dial and check for firm engagement at setting. This method provides reserve capacity based on 75 gallons per person.
 - Optional Programming Procedures
Calculate the gallon capacity of the system, subtract the necessary reserve requirement and set the gallons available at the small white dot on program wheel gear. Note, drawing shows 850 gallon setting. The capacity (gallons) arrow denotes remaining gallons exclusive of fixed reserve.
3. Rotate program wheel counterclockwise until it stops at **Regeneration** position.
4. Manually index the control to the **Backwash** position and allow water to flow at the drain for 3 or 4 minutes.
5. Remove back cover plate.
6. Make sure than the salt dosage is set as recommended by the manufacturer. Manually index the control to the **Brine Fill** position and allow the brine tank to fill to the top of the air check.
7. Manually index the control to the **Brine Rinse** position and allow the control to draw water from the brine tank until it stops.
8. Plug in the electrical cord and look in the sight hole in the back of the monitor to see that it is running.
9. Manually advance the control to the beginning of the **Brine Fill** position and allow the control to return to the **In Service** position automatically.
10. Fill the brine tank with salt.
11. Replace back cover on the control. Be sure cable is not pinched between cover and housing.
12. Make sure that any bypass valving is left in the normal **In Service** position.

Water Conditioner Flow Diagrams

Service Position

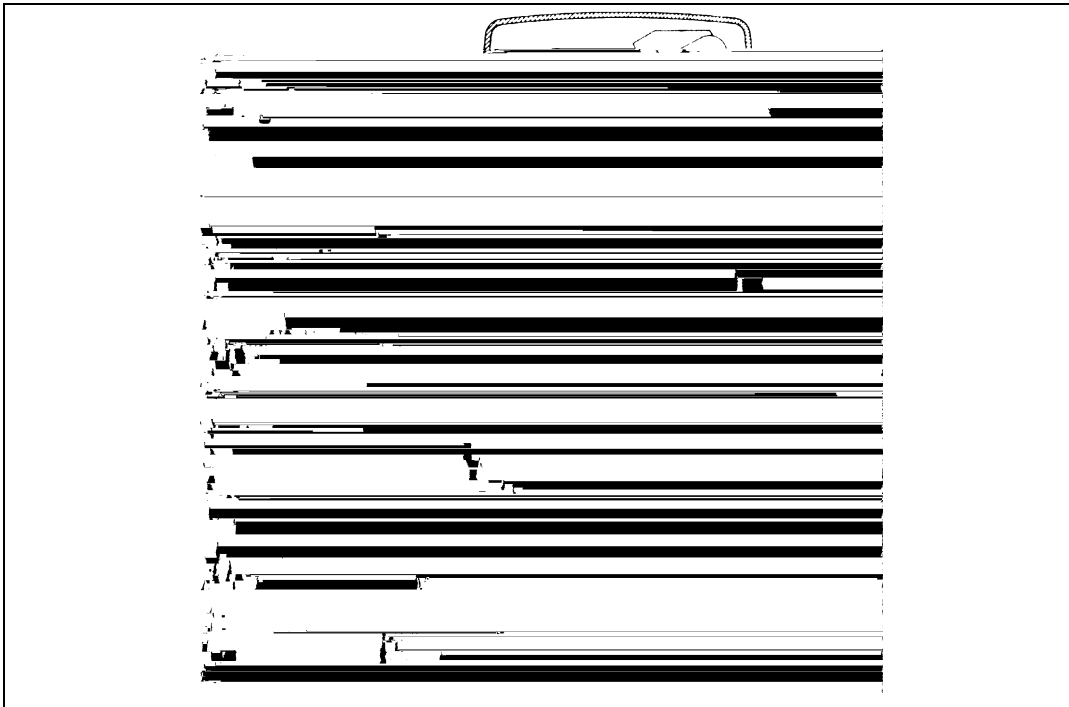

Figure 4: Service Position

Preliminary Rinse Position

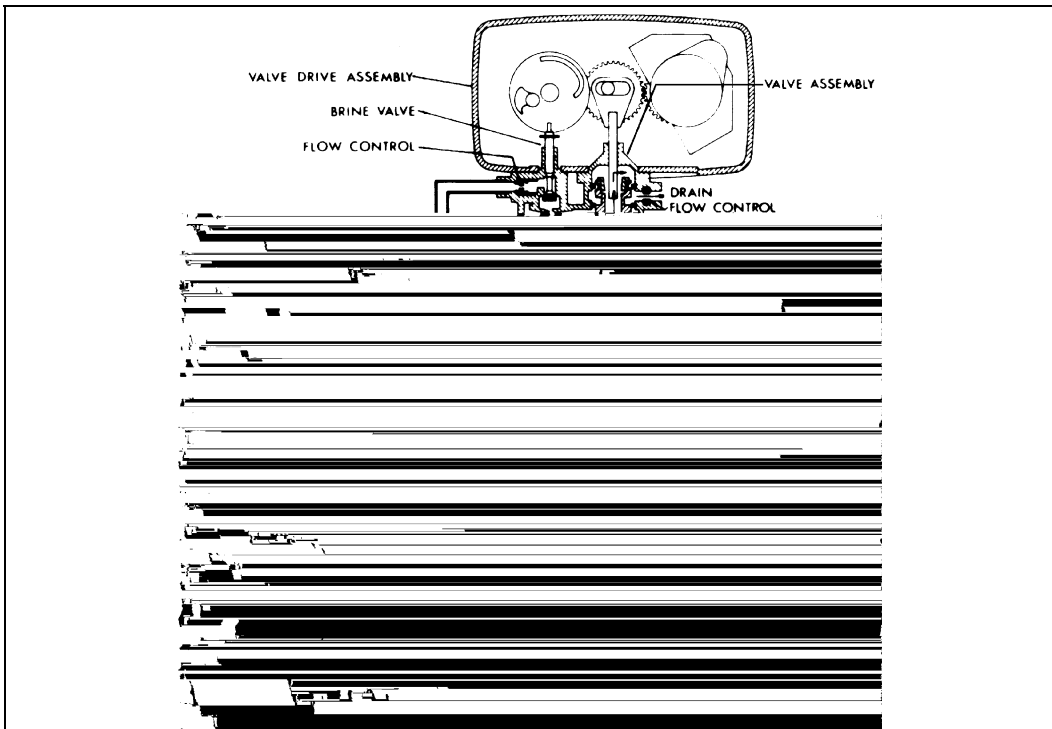

Figure 5: Preliminary Rinse Position

Water Conditioner Flow Diagrams (Cont'd.)

Backwash Position

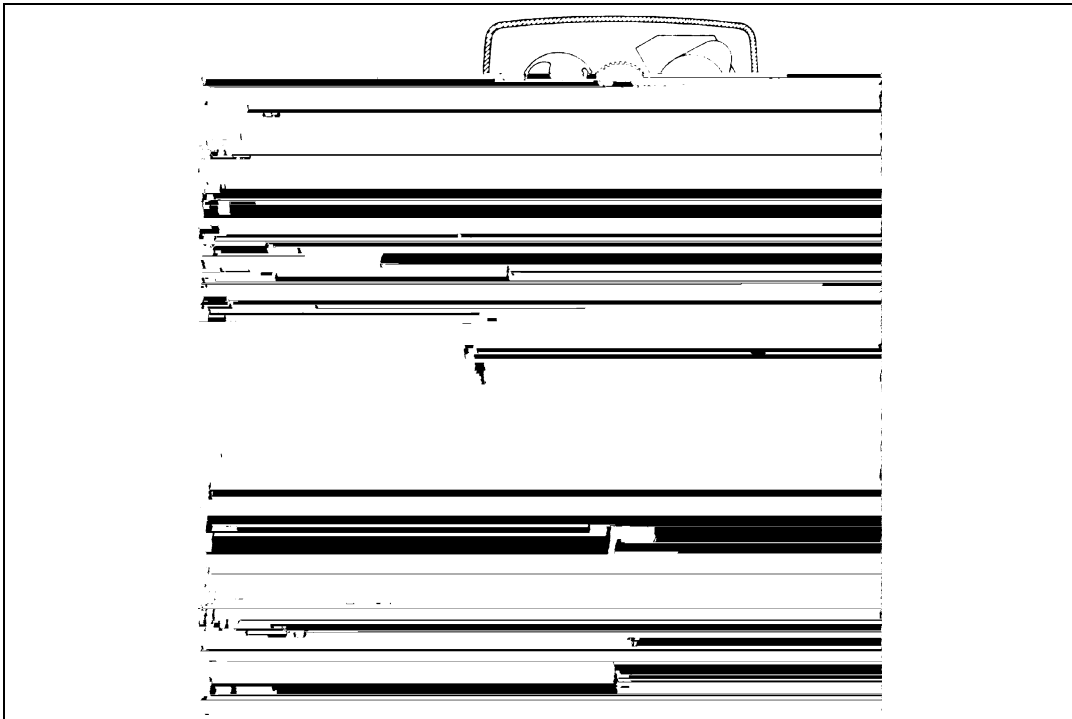

Figure 6: Backwash Position

Brine Position

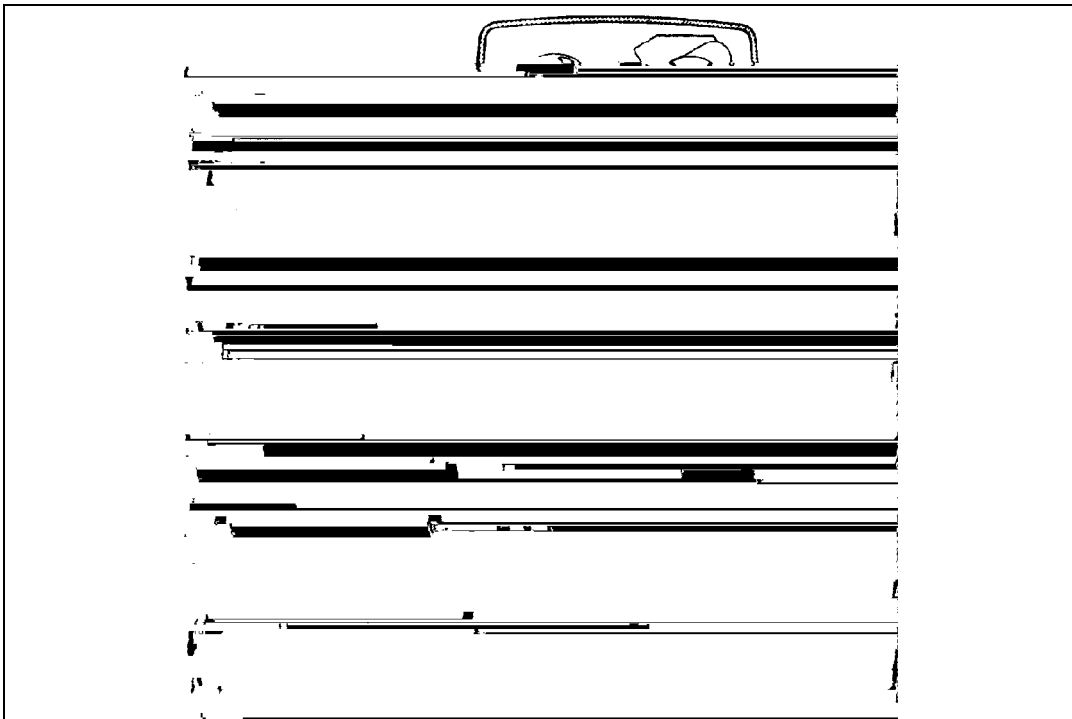

Figure 7: Brine Position

Water Conditioner Flow Diagrams (Cont'd.)

Slow Rinse Position

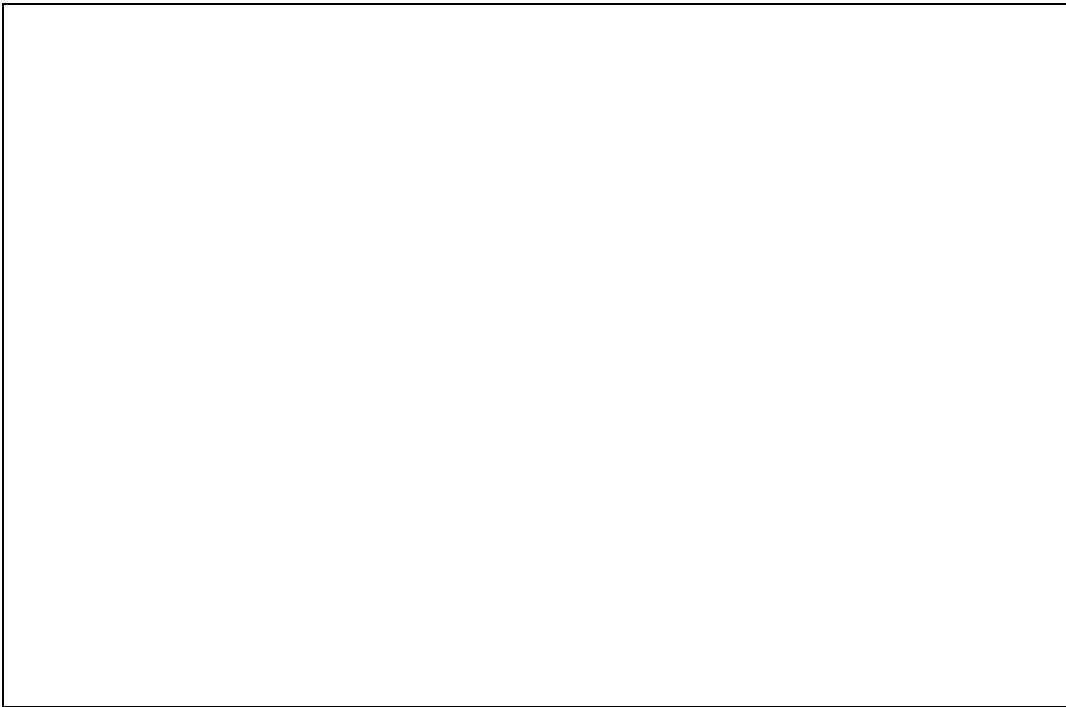

Figure 8: Slow Rinse Position

Second Backwash Position

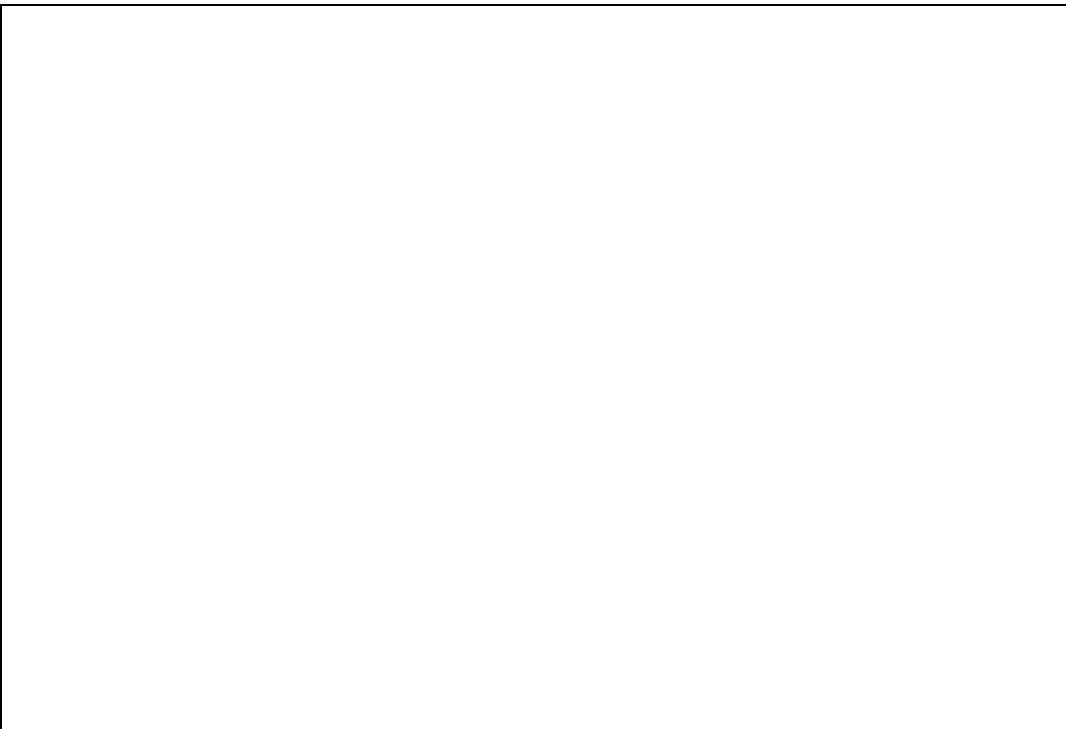

Figure 9: Second Backwash Position

Water Conditioner Flow Diagrams (Cont'd.)

Settling Rinse Position

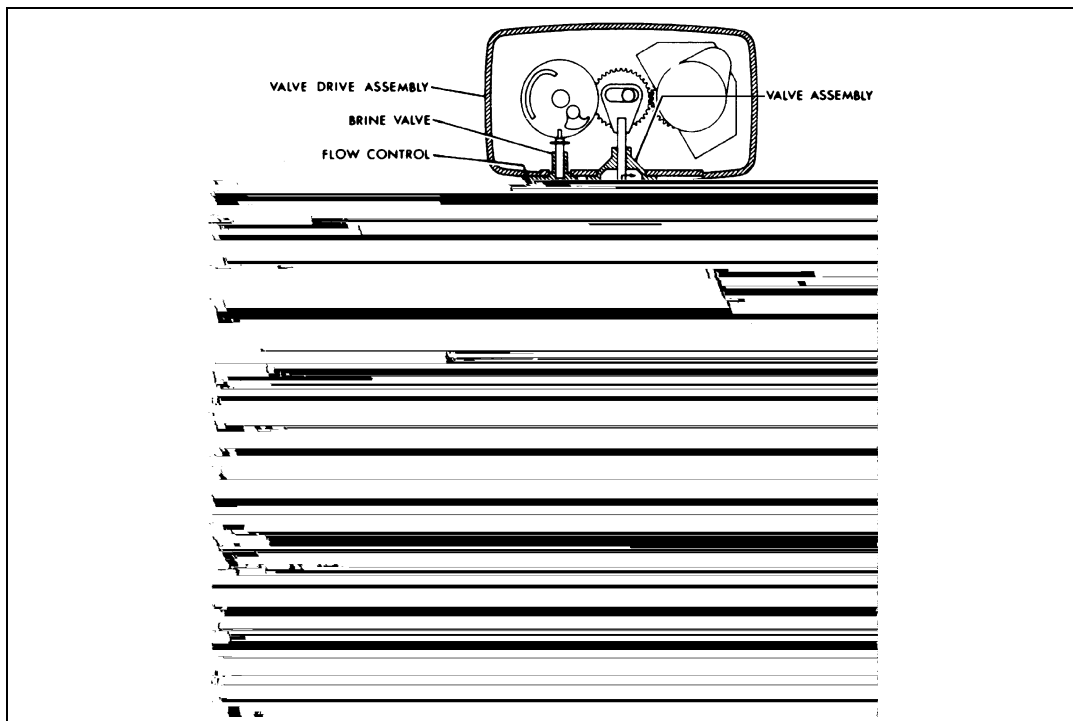

Figure 10: Settling Rinse Position

Brine Tank Fill Position

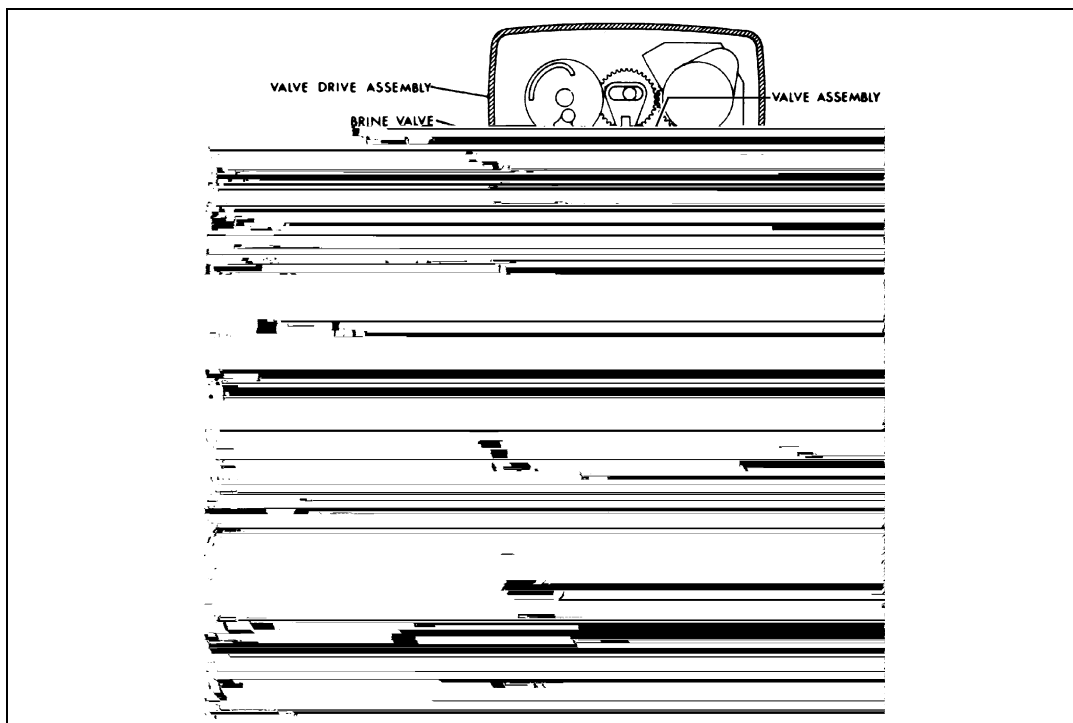

Figure 11: Brine Tank Fill Position

Model 5600 Control Valve Drive Assembly

Figure 12: Model

Model 5600 Control Valve Drive Assembly

Item Number	No. Req'd	Part Number	Description
1	1	14448-001	Drive Housing, with Pin Drilled for Cover
1A	1	15494-01	"L" Housing, with Pin
	1	15494-03	"L" Housing, with Pin Drilled for Designer
2	1	13175	Motor Mounting Plate
3	1	18743	Motor, 120V, 60 Hz
	1	19659	Motor, 24V, 60 Hz
4	(2-3)	11384	Screw, Motor Mtg. and Ground Wire
5	(3-5)	13296	Screw, Component Mounting
6	1	13017	Idler Gear
7	1	13018	Idler Pinion
8	1	13312	Spring, Idler
9	1	13164	Drive Gear
11	1	13170	Main Gear and Shaft
12	1	19205	24-hour Gear Assembly, Silver
	1	19205-01	24-hour Gear Assembly, Tan
13	1	13011	Cycle Actuator Gear
14	1	14177	Knob, Manual Regeneration
15	4	13300	Ball, 1/4" Dia.
16	2	13311	Spring, Detent, Skipper Wheel
19	1	14381	Skipper Wheel Assembly, 12-day
	1	14860	Skipper Wheel Assembly, 7-day
20	1	13864	Skipper Wheel Ring
21	2	19080	Spring, Compression, 6700
22	1	13014	Regeneration Pointer
23	1	11842	Electrical Cord, Standard
24	2	12681	Wire Connector (not shown)
25	1	13547	Strain Relief
26	1	13229	Back Cover
27	1	13309	Front Label, Brown on Beige
	1	13437	Front Label, Blue/Silver on Black
28	1	13310	Rear Label, Softener
	1	18520	Rear Label, Filter
29	1	13348	Tape Stripe, Brown on Beige
	1	13436	Tape Stripe, Blue on Silver
30s	1	60514	Brine Cam Assembly, 3-18
	1	60514-01	Brine Cam Assembly, 6-36
	1	60514-02	Brine Cam Assembly, Minutes
34	2	12473	Screw-drive Mounting
35s	1	12037	Washer
37	1	15151	Screw, Knob
38	1	14176	Valve Position Dial, Standard
	1	14278	Valve Position Dial, Low Water
	1	15478	Valve Position Dial, Chemical Filter
	1	16715	Valve Position Dial, Filter
39	1	14175	Knob Label, Beige
	1	14207	Knob Label, Silver
40s	1	40214	Screw, Brine Cam

s Not used when a filter valve

Model 5600 and 5600 Econominder Control Valve Drive Assembly

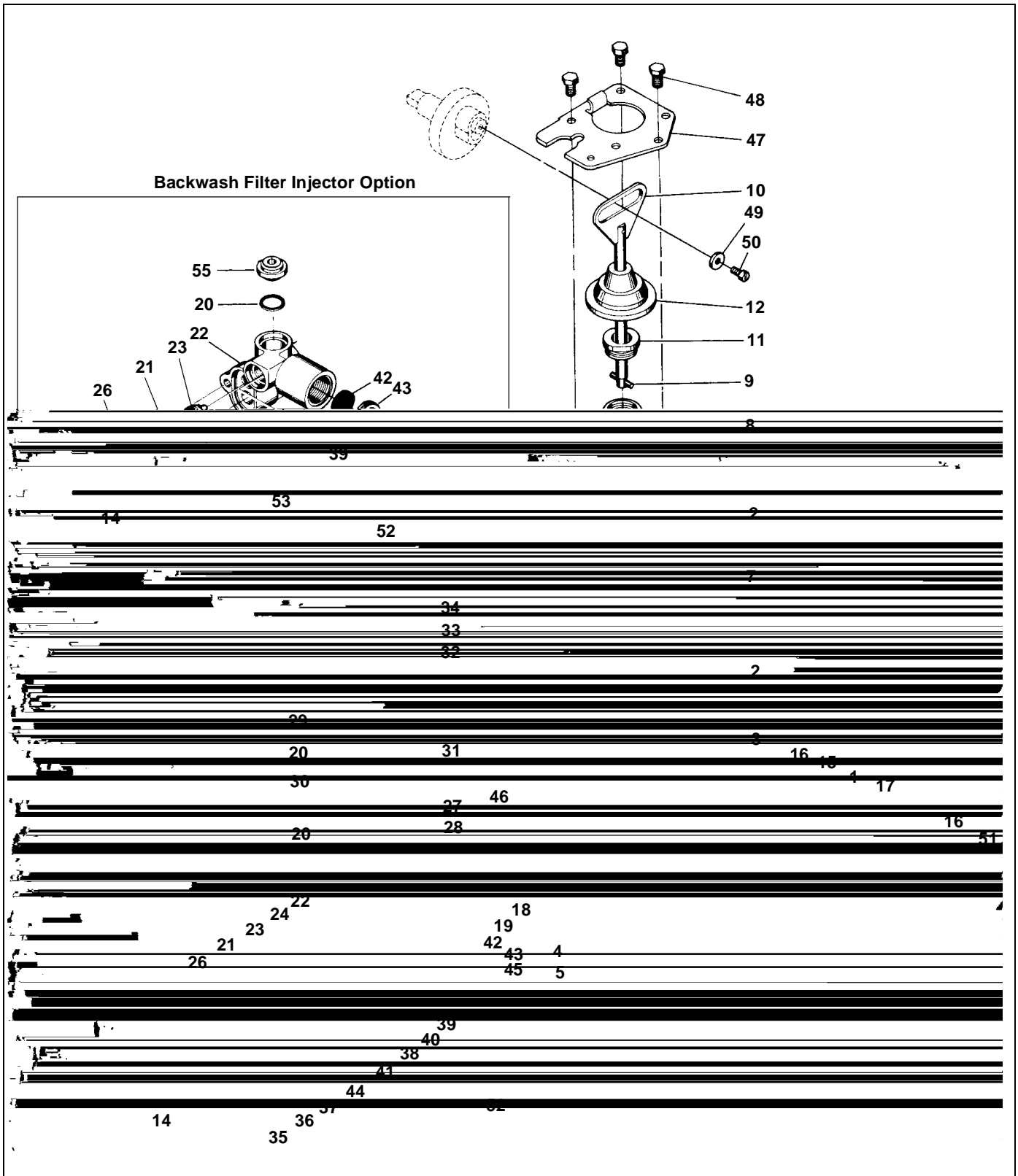

Figure 13: Model 5600 and 5600 Econominder Control Valve Drive Assembly

Model 5600 and 5600 Econominder Control Valve Drive Assembly

Item Number	No. Req'd	Part Number	Description
1	2-4	13255	Adapter Clip (Clock or Meter)
2	5	13242	Seal
	5	17772	Silicone Seal
3	1	61400-12	Valve Body Assembly, 1" Dist.
	1	61400-11	Valve Body Assembly, 3/4" Dist.
4	1	13304	O-ring, Distributor Tube, 1"
	1	10244	O-ring, Distributor Tube, 13/16"
5	1	12281	O-ring 1610903.838o61095 T4(61)-9.33(t)11.0(b) -19.4(6)8.6(4)s25.1(i)-11.gt2

* not used with meter controls
 S used in backwash filter

Model 5600 Econominder Control Valve Drive Assembly

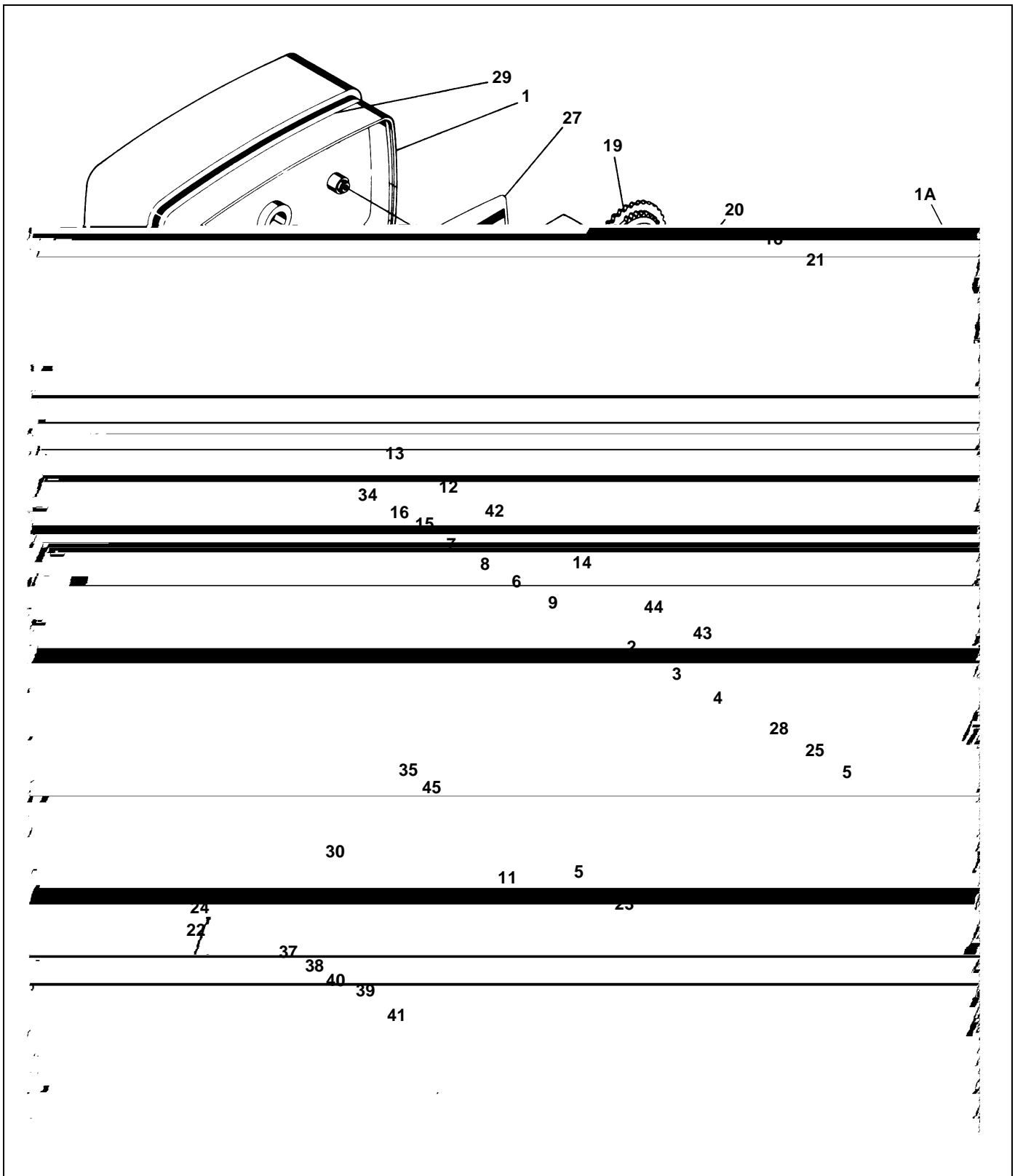

Figure 14: Model 5600 Econominder Control Valve Drive Assembly

Model 5600 Econominder Control Valve Drive Assembly

Item Number	No. Req'd	Part Number	Description
1	1	14488-001	Drive Housing, with Pin Drilled for Cover
1A	1	15494-01	"L" Housing, with Pin
	1	15494-03	"L" Housing, with Pin Drilled for Designer
2	1	13175	Motor Mounting Plate
3	1	18743	Motor, 120V, 60 Hz
	1	13494	Motor, 24V, 60 Hz
4	2-3	11384	Screw, Motor Mtg. and Ground Wire
5	2-4	13296	Screw, Component Mounting
6	1	13017	Idler Gear
7	1	13018	Idler Pinion
8	1	13312	Spring, Idler
9	1	13164	Drive Gear
11	1	13170	Main Gear and Shaft
12	1	19205	24-hour Gear Assembly, Silver
	1	19205-01	24-hour Gear Assembly, Tan
13	1	13802	Cycle Actuator Gear
14	1	14177	Knob, Manual Regeneration
15	2	13300	Ball, 1/4" Dia.
16	2	19080	Spring, Compression, 6700
18	1	13748	Screw, Program Wheel
19	1	60405-15	Program Skipper Wheel Assembly, Specify Hardness Capacity
20	1	13806	Program Wheel Retainer
21	1	13953	Cover Label, Program Wheel
22	1	11842	Electrical Cord
23	2	12681	Wire Connector
24	1	13547	Strain Relief
25	1	13229	Back Cover
26			not assigned
27	1	13955	Front Label, Beige
	1	13958	Front Label, Silver
28	1	13310	Rear Label, Softener
	1	18520	Rear Label, Filter
29	1	13957	Tape Stripe, Beige
	1	13960	Tape Stripe, Silver
30	1	60514	Brine Cam Assembly, 3-18
	1	60514-01	Brine Cam Assembly, 6-36
	1	60514-02	Brine Cam Assembly, Minutes
34	2	12473	Screw-drive Mounting
35	1	12037	Washer
37	1	13830	Drive Pinion, Program Wheel
38	1	13831	Clutch, Drive Pinion
39	1	14253	Spring Retainer
40	1	14276	Spring
41	1	14043	Cable Assembly, Standard
	1	14910	Cable Assembly, Extended, Right Angle
42	1	14176	Valve Position Dial, Standard
	1	14278	Valve Position Dial, Low Water
	1	15478	Valve Position Dial, Filter
43	1	14175	Knob Label, Beige
	1	14207	Knob Label, Silver
44	1	15151	Screw, Knob
45	1	40214	Screw, Brine Cam

Bypass Valve Assembly, Plastic



Figure 15: Bypass Valve Assembly, Plastic

Item Number	No. Req'd	Part Number	Description
9	2	13305	O-ring, 119
10	2	13255	Clip, Mounting
11	2	13314	Screw, Hex Washer Head, #8-18 x 5/8"
12A	1	18706	Yoke, Plastic 1" NPT
	1	18706-02	Yoke, Plastic 3/4"
12B	1	13708	Yoke, 3/4"
	1	13708NP	Yoke, 3/4" (Nickel-plated)
	1	13398	Yoke, 1"
	1	13398NP	Yoke, 1" (Nickel-plated)

Bypass Valve Assembly, Brass

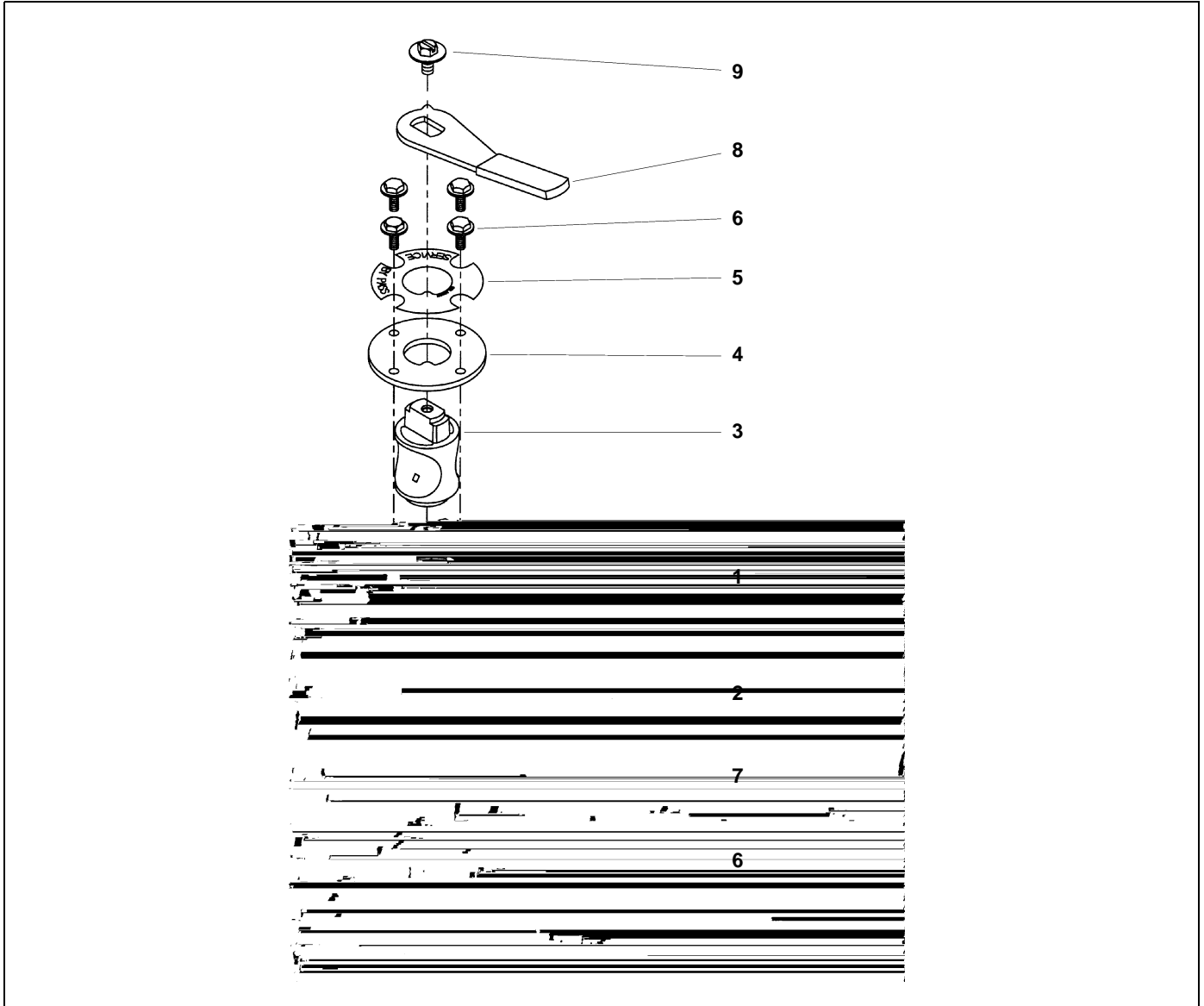

Figure 16: Bypass Valve Assembly, Brass

Item Number	No. Req'd	Part Number	Description
1	1	17290	Bypass Valve Body, 3/4"
	1	17290NP	Bypass Valve Body, 3/4"
	1	13399	Bypass Valve Body, 1"
	1	13399NP	Bypass Valve Body, 1" (Nickel-plated)
2	1	11726	Seal, Bypass
3	1	11972	Plug, Bypass
4	1	11978	Side Cover
5	1	13604-01	Label
6	8	15727	Screw
7	1	11986	Side Cover
8	1	11979	Lever, Bypass
9	1	11989	Screw, Hex Head, 1/4-14

Model 5600 Econominder Meter Assembly

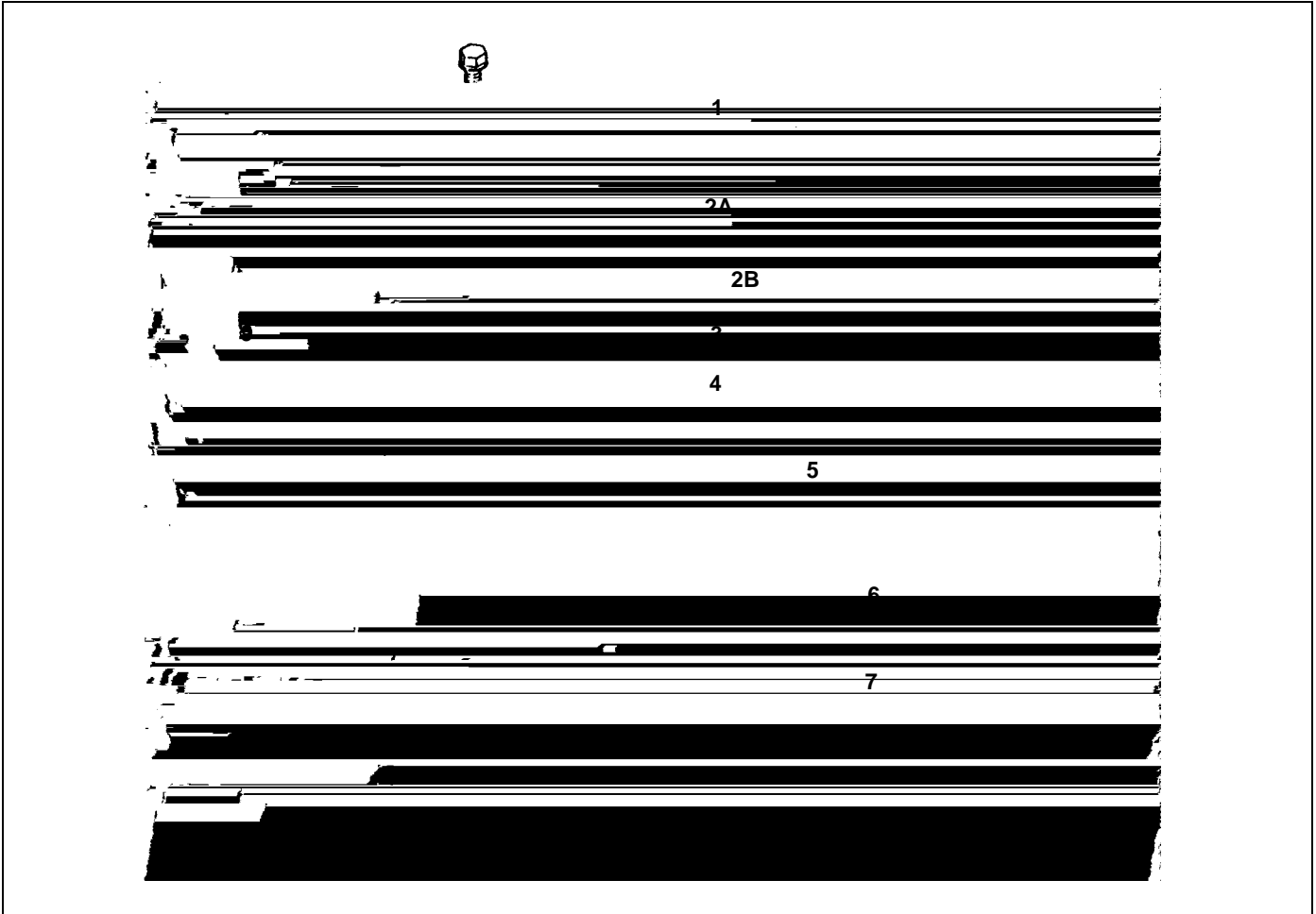

Figure 17: Model **5600 Econominder** Meter Assembly

Item Number	No. Req'd	Part Number	Description
1	4	12473	Screw, Meter Cover Assembly
2A	1	14038	Meter Cover Assembly, Standard
2B	1	15659	Meter Cover Assembly, Extended Range (Right Angle)
3	1	13847	O-ring, Meter Cover Assembly
4	1	13509	Impeller
5	4	13314	Screw, Adapter Clip
6	4	13255	Adapter Clip
7	1	13821	Meter Body
8	4	13305	O-ring, Meter Body
9	1	14613	Flow Straightener

Replace Time Brine Valve, Injectors and Screen

1. Unplug electrical cord from outlet.
2. Turn off water supply to conditioner:
 - If the conditioner installation has a “three valve” bypass system, first open the valve in the bypass line, then close the valves at the conditioner inlet and outlet.
 - If the conditioner has an integral bypass valve, put it in the **Bypass** position.
 - If there is only a shut-off valve near the conditioner inlet, close it.

Service Instructions (Cont'd.)

Replace Timer

1. Unplug electrical cord from outlet.
2. Turn off water supply to conditioner:
 - If the conditioner installation has a “three valve” bypass system, first open the valve in the bypass line, then close the valves at the conditioner inlet and outlet.
 - If the conditioner has an integral bypass valve, put it in the **Bypass** position.
 - If there is only a shut-off valve near the conditioner inlet, close it.
3. Relieve water pressure in the conditioner by putting the control in the **Backwash** position momentarily. Return the control to the **In Service** position.
4. Pull cable out of meter cover. Remove the control valve back cover.
5. Remove screw and washer at drive yoke. Remove timer mounting screws. The entire timer assembly now lifts off easily.
6. Put new timer on top of valve. Be sure drive pin on main gear engages slot in drive yoke (rotate control knob if necessary).
7. Replace timer mounting screws. Replace screw and washer at drive yoke.
8. Return bypass or inlet valving to normal **In Service**

Replace Piston Assembly

1. Unplug electrical cord from outlet.
2. Turn off water supply to conditioner:
 - If the conditioner installation has a “three valve” bypass system, first open the valve in the bypass line, then close the valves at the conditioner inlet and outlet.
 - If the conditioner has an integral bypass valve, put it in the **Bypass** position.
 - If there is only a shut-off valve near the conditioner inlet, close it.
3. Relieve water pressure in the conditioner by putting the control in the **Backwash** position momentarily. Return the control to the **In Serctent**

Service Instructions (Cont'd.)

Replace Seals and Spacers

1. Unplug electrical cord from outlet.
2. Turn off water supply to conditioner:
 - If the conditioner installation has a “three valve” bypass system, first open the valve in the bypass line, then close the valves at the conditioner inlet and outlet.
 - If the conditioner has an integral bypass valve, put it in the **Bypass** position.
 - If there is only a shut-off valve near the conditioner inlet, close it.
3. Relieve water pressure in the conditioner by putting the control in the **Backwash** position momentarily. Return the control to the **In Service** position.
4. Pull cable out of meter cover. Remove the control valve back cover.
5. Remove screw and washer at drive yoke. Remove timer mounting screws. The entire timer assembly now lifts off easily. Remove end plug retainer plate.
6. Pull upward on end of piston rod yoke until assembly is out of valve. Remove and replace seats and spacers with fingers.

Service Instructions (Cont'd.)

Replace Meter

1. Unplug electrical cord from outlet.
2. Turn off water supply to conditioner:
 - If the conditioner installation has a “three valve” bypass system, first open the valve in the bypass line, then close the valves at the conditioner inlet and outlet.
 - If the conditioner has an integral bypass valve, put it in the **Bypass** position.

Replace Meter Cover and/or Impeller

1. Unplug electrical cord from outlet.
2. Turn off water supply to conditioner:
 - If the conditioner installation has a “three valve” bypass system, first open the valve in the bypass line, then close the valves at the conditioner inlet and outlet.
 - If the conditioner has an integral bypass valve, put it in the **Bypass** position.
 - If there is only a shut-off valve near the conditioner inlet, close it.
3. Relieve water pressure in the conditioner by putting the control in the **Backwash** position momentarily. Return the control to the **In Service** position.
4. Pull cable out of meter cover.
5. Remove four screws on cover
6. Lift cover off of meter module, discard O-ring.
7. Remove and inspect impeller for gear or spindle damage, replace if necessary.
8. Apply silicone lubricant to new O-ring and assemble to the smallest diameter on meter cover.
9. Assemble cover to meter module. Be sure impeller spindle enters freely into cover. Press firmly on cover and rotate if necessary to assist in assembly.
10. Replace four screws and tighten.
11. Return bypass or inlet valving to normal **In Service** position. Water pressure automatically builds in the conditioner.

NOTE: Be sure to shut off any bypass line.
12. Check for leaks at all seal areas.
13. Plug electrical cord into outlet.
14. Set time of day.
 - Make sure control valve is in the **In Service** position.
15. Rotate program wheel counterclockwise until it stops at **Regeneration** position.
16. Start regeneration cycle manually if water is hard.
17. Plug cable into meter cover. Rotate cable to align drive flat if necessary.

Model 5600 and 5600 Econominder Troubleshooting

PROBLEM	CAUSE	CORRECTION
1. Softener fails to regenerate.	<ul style="list-style-type: none"> A. Electrical service to unit has been interrupted. B. Timer is defective. C. Power failure. 	<ul style="list-style-type: none"> A. Assure permanent electrical service (check fuse, plug, pull chain or switch). B. Replace timer. C. Reset time of day.
2. Softener delivers hard water.	<ul style="list-style-type: none"> A. Bypass valve is open. B. No salt in brine tank. C. Injectors or screen is plugged. D. Insufficient water flowing into brine tank. E. Hot water tank hardness. F. Leak at distributor tube. G. Internal valve leak. 	<ul style="list-style-type: none"> A. Close bypass valve. B. Add salt to brine tank and maintain salt level above water level. C. Replace injectors and screen. D. Check brine tank fill time and clean brine line flow control if plugged. E. Repeated flushings of the hot water tank is required. F. Make sure distributor tube is not cracked. Check O-ring and tube pilot. G. Replace seals and spacers and/or piston.
3. Unit uses too much salt.	<ul style="list-style-type: none"> A. Improper salt setting. B. Excess water in brine tank. 	<ul style="list-style-type: none"> A. Check salt usage and salt setting. B. See problem number 7.
4. Loss of water pressure.	<ul style="list-style-type: none"> A. Iron build-up in line to water conditioner. B. Iron build-up in water conditioner. C. Inlet of control plugged due to foreign material loose from pipes by recent work done on plumbing system. 	<ul style="list-style-type: none"> A. Clean line to water conditioner. B. Clean control and add resin cleaner to resin bed. Increase frequency of regeneration. C. Remove piston and clean control.
5. Loss of resin through drain line.	<ul style="list-style-type: none"> A. Air in water system. 	<ul style="list-style-type: none"> A. Assure that well system has proper air elimination control, check for dry well condition.
6. Iron in conditioned water.	<ul style="list-style-type: none"> A. Fouled resin bed. 	<ul style="list-style-type: none"> A. Check backwash, brine draw and brine tank fill, increase frequency of regeneration, increase backwash time.
7. Excessive water in brine tank.	<ul style="list-style-type: none"> A. Plugged drain line flow control. 	<ul style="list-style-type: none"> A. Clean flow control.
8. Salt water in service line.	<ul style="list-style-type: none"> A. Plugged injector system. B. Timer not cycling. C. Foreign material in brine valve. D. Foreign material in brine line flow control. 	<ul style="list-style-type: none"> A. Clean injector and replace screen. B. Replace timer. C. Clean or replace brine valve. D. Clean brine line flow control.

Model 5600 and 5600 Econominder Troubleshooting (Cont'd.)

PROBLEM

CAUSE

CORRECTION

General Service Hints for Meter Control

Model 5600SF Troubleshooting

PROBLEM	CAUSE	CORRECTION
1. Filter fails to backwash.	<ul style="list-style-type: none"> A. Electrical service to unit has been interrupted. B. Timer is defective. C. Power failure. 	<ul style="list-style-type: none"> A. Assure permanent electrical service (check fuse, plug, pull chain or switch). B. Replace timer. C. Reset time of day.
2. Filter "bleeds" iron.	<ul style="list-style-type: none"> A. Bypass valve is open. B. Excessive water usage. C. Hot water tank rusty. D. Leak at distributor tube. E. Defective or stripped filter medium bed. F. Inadequate backwash flow rate. 	<ul style="list-style-type: none"> A. Close bypass valve. B. Reduce days between, backwashing (see timer instructions), make sure that there is not a leaking valve in the toilet bowl or sinks. C. Repeated flushings of the hot water tank is required. D. Make sure distributor tube is not cracked, check O-ring and tube pilot. E. Replace bed. F. Make sure filter has correct drain flow control, be sure flow control is not clogged or drain line restricted, be sure water pressure has not dropped, increase backwash flow rate according to specifications for your unit, see your dealer for recommendations.
3. Loss of water pressure.	<ul style="list-style-type: none"> A. Iron or turbidity build-up in water filter. B. Inlet plugged due to foreign material broken loose from pipes by recent work done on plumbing system. 	<ul style="list-style-type: none"> A. Reduce days between backwashing so filter backwashes more often, make sure filter is sized large enough to handle water usage. B. Remove piston and clean control.
4. Loss of filter medium through drain line.	<ul style="list-style-type: none"> A. Broken or missing top screen. 	<ul style="list-style-type: none"> A. Replace top screen, must have 0.020" wide slots.
5. Drain flows continuously.	<ul style="list-style-type: none"> A. Foreign material in control. B. Internal control leak. C. Control valve jammed in rinse or backwash. 	<ul style="list-style-type: none"> A. Remove piston assembly and inspect bore, remove foreign material and check control in various cycle positions. B. Replace seals and/or piston assembly. C. Replace piston, seals and spacers (and drive motor if necessary).

Service Assemblies

<i>Part Number</i>	Description
60102-00	Piston, Softener
60102-10	Piston, Filter
60102-20	Piston, Low Water
60125	Seal Kit
60084-XX	Injector
60032	Brine Valve
60514	Brine Cam, 3-18
60514-01	Brine Cam, 6-36
60514-02	Brine Cam, Minutes
60510	Coupling, with Clip and Screws
60040	Bypass, Brass 3/4" NPT
60041	Bypass, Brass 1" NPT

Notes:
